

DONVEY

CABLE MANAGEMENT SYSTEMS

- Cable Trays
- Cable Tray Accessories
- Cable race ways
- Electrical Junction Boxes

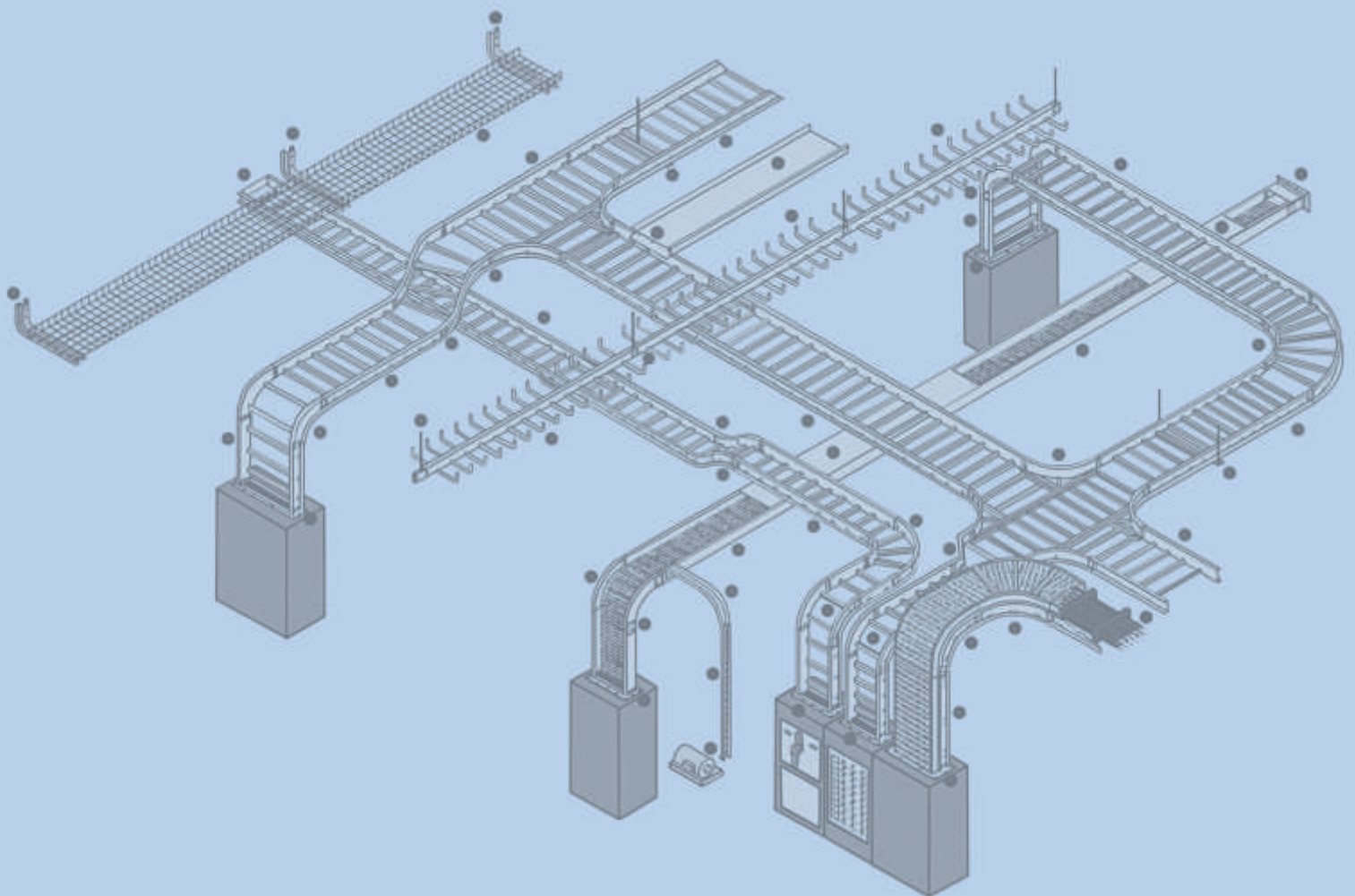

Company Profile

DONVEY Engineering and technologies is a leading manufacturer and supplier of cable trays , raceways & junction boxes in India and has been the market leader for over 24 years in cable trays for segments like Construction, Manufacturing, IT/ITes, Telecom, Services, Govt. & Healthcare Industry.

Perforated Cable Trays

The perforated category comes in widths ranging from 50 mm to 1000 mm. They have the capacity for standard support span of 2,500 mm. These perforated cable trays are specially engineered making use of quality **HR Sheets, Stainless Steel Sheets and pre galvanized Sheets** with specific thickness and flange heights. Some of its important specifications are given below

Types of folds

Straight Type Fold

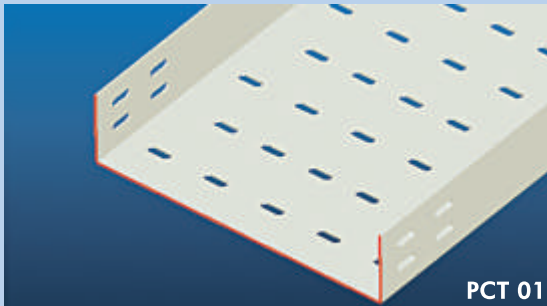

Return Flange Inside Type Fold

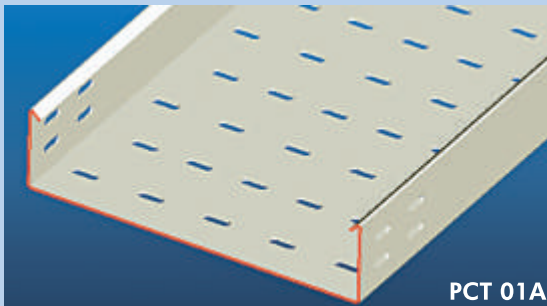

C Type Inside Fold

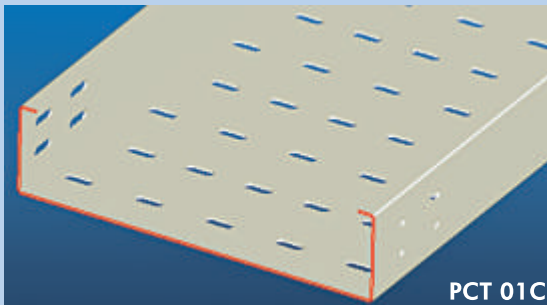

Side height Dimensions

13	25	50	75	100	upto	300
----	----	----	----	-----	------	-----

Material Thickness

1.0	1.2	1.6	2.0	2.5		
-----	-----	-----	-----	-----	--	--

Available Finishes

Stainless steel	SS
Pre-Galvanised steel	PG
Hot dip Galvanised	HG
Electrolytic Galvanised steel	EG
Powder coating	PC
Epoxy / Enamel Coating	PA

Return Flange Outside Type Fold

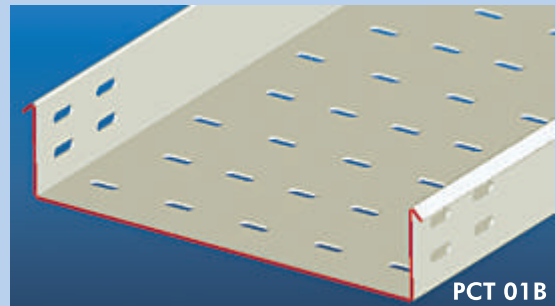

C Type Outside Fold

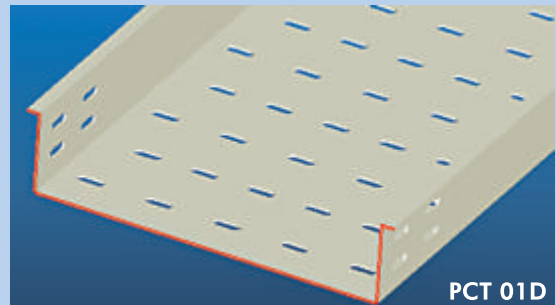

Types of Perforation

Staggered Perforation



Serial Perforation



Perforated Cable Trays

Straight Type

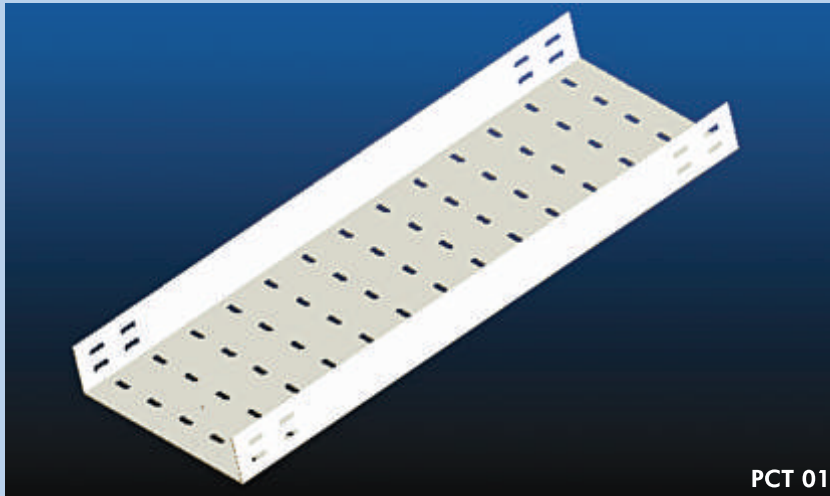

PCT 01

Cable Tray Closer / Cover

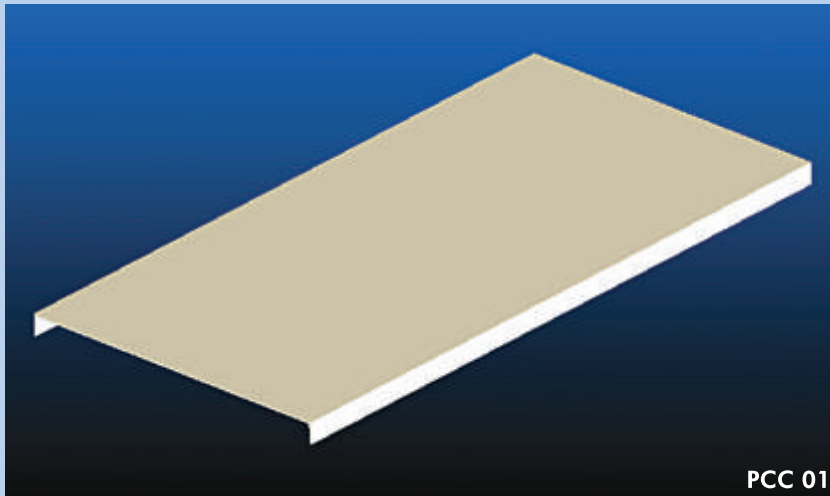

PCC 01

Ladder Type Cable Tray

The Ladder Type Cable Trays are manufactured in the width from 150 mm to 900 mm : having Height from 50 mm to 150 mm and the Thickness from 1.6 mm to 2.5 mm with all accessories. These trays consists of two longitudinal side rails connected by individual transverse members.

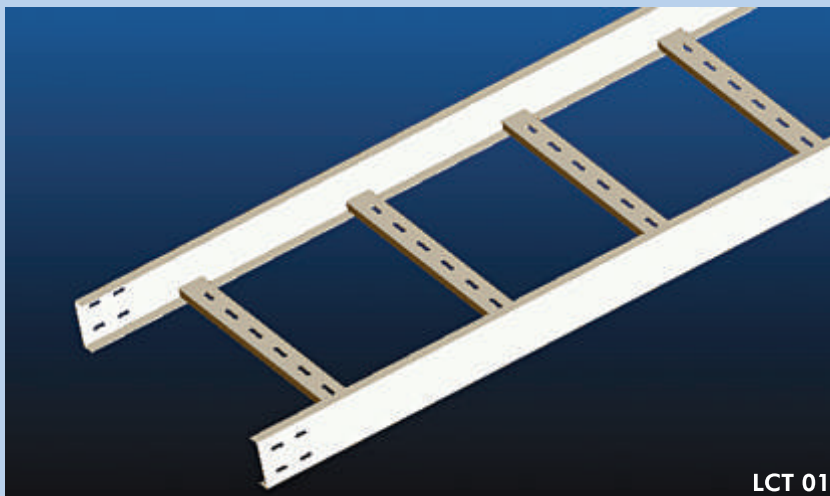

LCT 01

Thickness Vs Width Standards

For thk 1.0 mm Widths are	For thk 1.2mm Widths are	For thk 1.6 mm Widths are	For thk 2.0 mm Widths are
50	50	50	50
75	75	75	75
100	100	100	100
125	125	125	125
150	150	150	150
200	200	200	200
225	250	250	250
	300	300	300
	350	350	350
	400	400	400
	450	450	450
		500	500
		550	550
		600	600
		650	650
			700
			750
			800
			850
			900
			950
			1000

The above are standard thickness, can make other thickness also as per customer drawings.

Service duration chart for all coatings in an Industrial Environment.

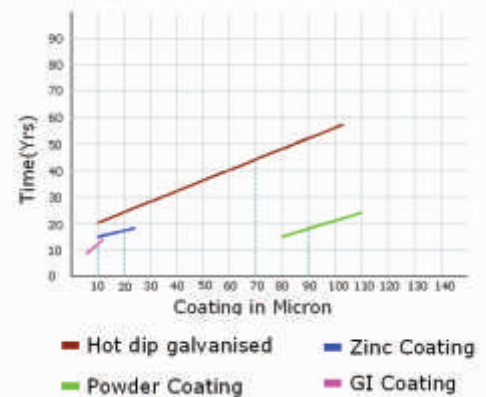

Cable Tray accessories

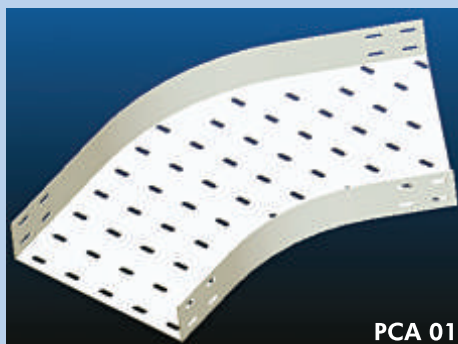

PCA 01

Curved Bend 45 degree

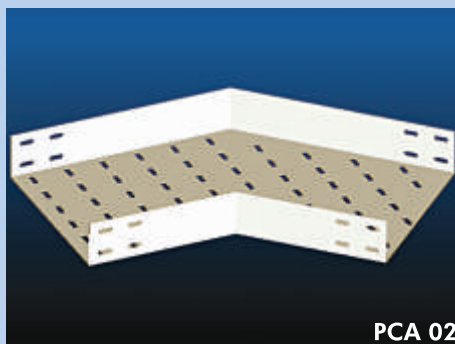

PCA 02

Cornered Bend 45 degree

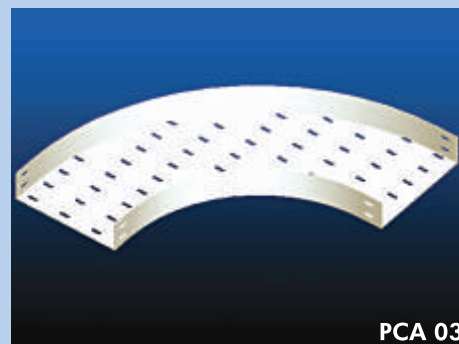

PCA 03

Curved Bend 90 degree

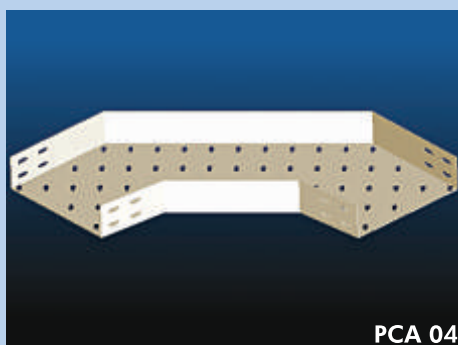

PCA 04

Cornered Bend 90 degree

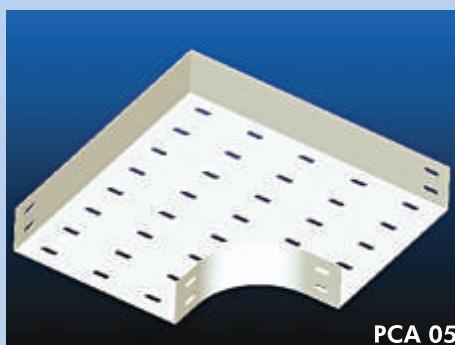

PCA 05

Short Bend 90 degree

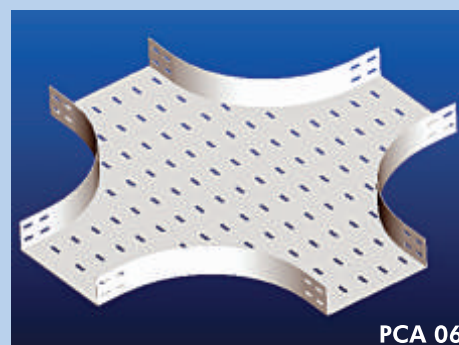

PCA 06

Intersection Curved

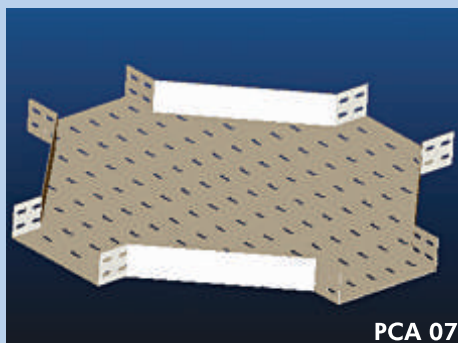

PCA 07

Intersection Cornered

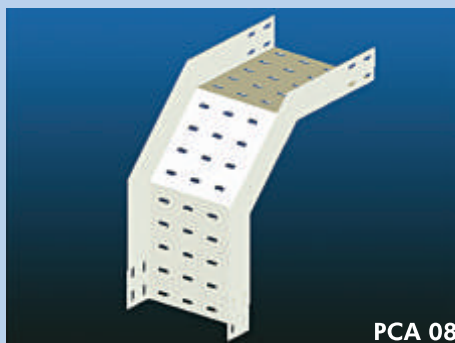

PCA 08

90 Degree Outside Raiser
Cornered

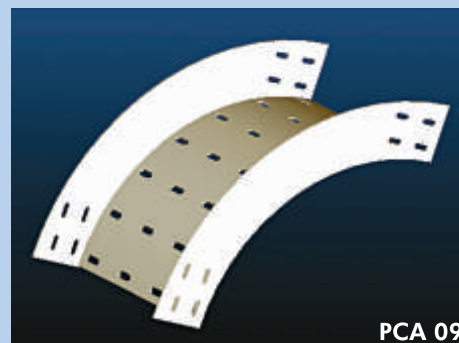

PCA 09

90 Degree Outside Raiser
Curved

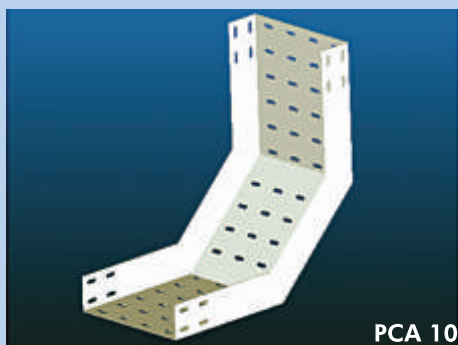

PCA 10

90 Degree Inside Raiser
Cornered

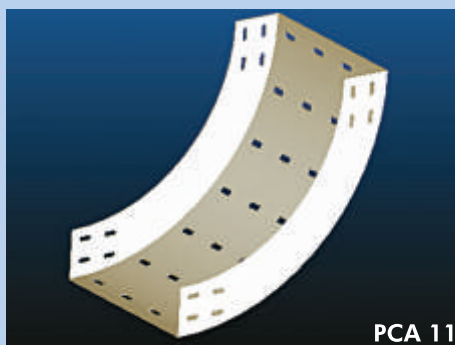

PCA 11

90 Degree Inside Raiser
Curved

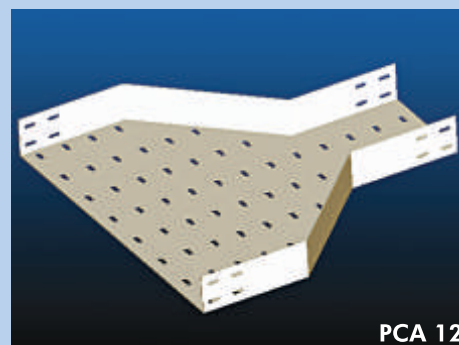

PCA 12

Reducer Centre

Cable Tray Accessories

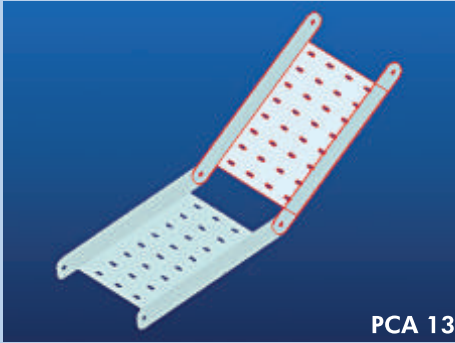

Adjustable Raiser

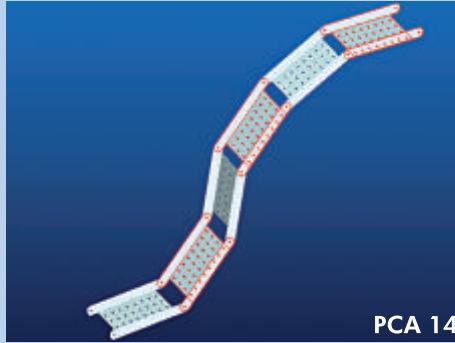

Custom Raiser

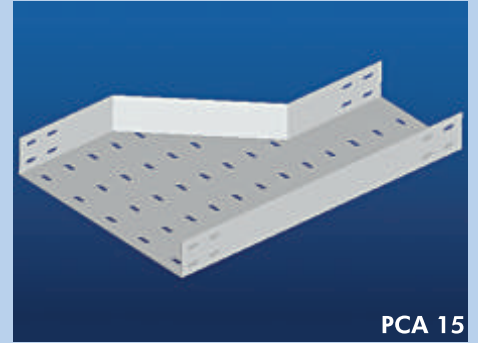

Reducer Left Side

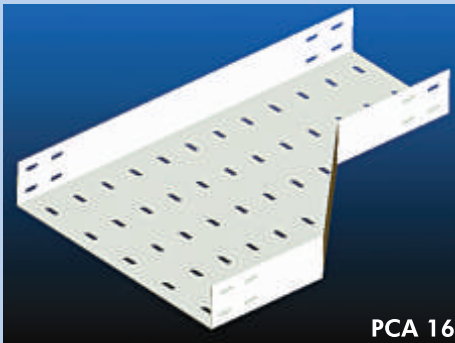

Reducer Right Side

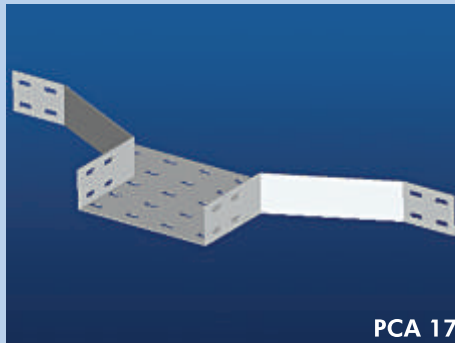

Add on Cornered

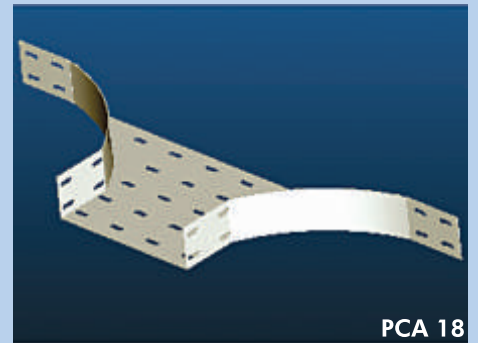

Add on Curved

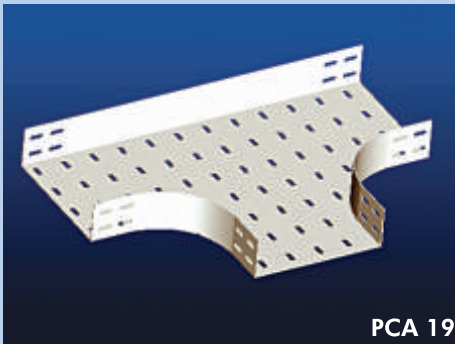

Tee Curved

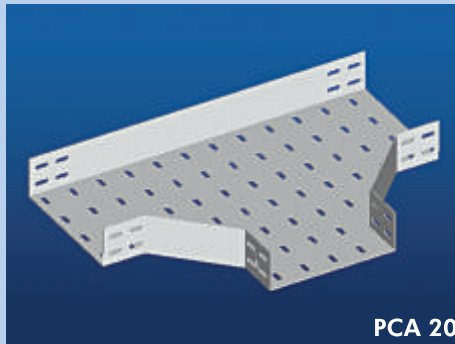

Tee Cornered



Ladder Type Bend

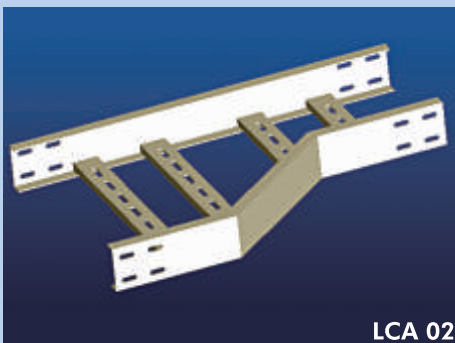

Ladder Type Reducer



Ladder Type 90 Degree Inside Raiser

Design Factor to Consider:

Consideration should be given to the following factors when undertaking the design of a cable tray run and a support system, although some of these (ex: wind loads) may not be relevant to every installation

- * Distributed loads eg: Cables, pipes
- * Point loads
- * Thermal expansion
- * Wind and external force
- * Spacing of supports
- * safety factor
- * Deflection

Electrical Junction Box

DONVEY is a specialist manufacturer of standard and customised enclosures for the electrical switchgear and control panel industry.

Our management team, designers and workshop engineers have many years experience in the sheet metal fabrication industry. We use CAD/CAM techniques for all our design and manufacturing processes. DONVEY has gained a reputation for producing excellent quality products as well as achieving very tight delivery deadlines.

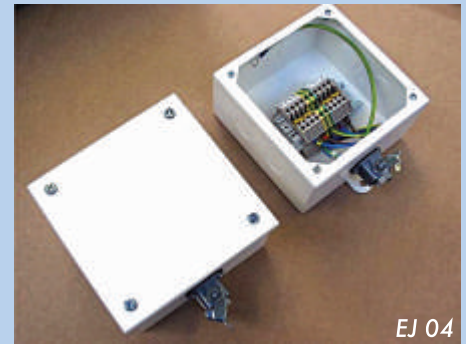

RAL Colours



Some of our Reputed Clients

- Hyundai Motor India Ltd
- Orbis India Ltd
- Sundaram Clayton Ltd
- Iljin Automotive Ltd
- TIDC India
- Lucas-TVS
- Rane Group
- Brakes India Ltd

DONVEY POWER CONTROL SYSTEMS PVT. LTD.,

NO. 47, Udhaya Nagar, Porur, Chennai – 600 116.
Ph. -9840151458/9840856851 | E Mail – donveyldc@gmail.com |
salessupport@donvey.com | customersupport@donvey.com |

www.donveypower.com